

Article number: 201580M820PL

Description: E+G Screw GN 1580-M8-20-PL-H
Hygienic design

Measures

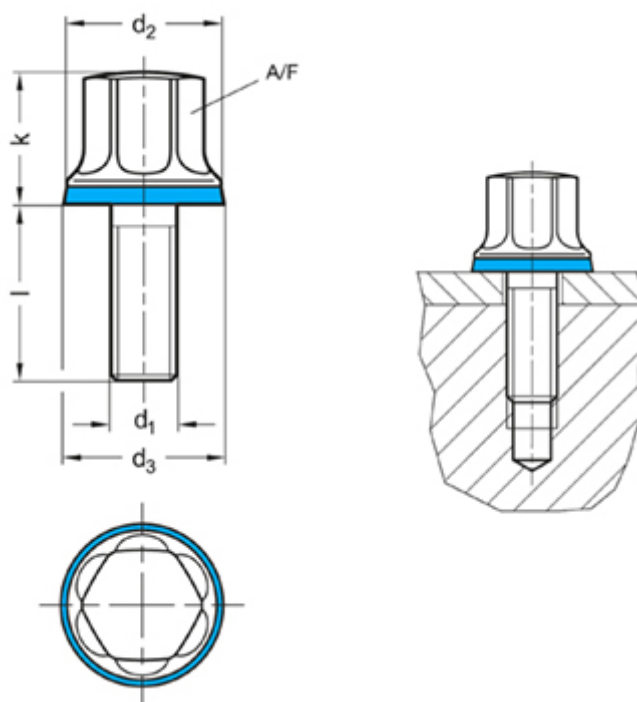

d1	= M 8
d2	= 18
d3	= 18.8
k	= 14.5
L	= 20
t min	= -
Weight in (g)	= 23